

CLASS T 300 & 600 Volt Fuse Blocks

300 & 600V Class T Fuse Blocks

Mersen Class T fuse blocks accommodate Class T fuses up to 600A. Insulators are either durable, glass-filled polycarbonate (GFPC) or phenolic with verified dielectric strength in excess of 2500V. Mersen is the only manufacturer to offer Class T blocks with copper connectors.

Features/Benefits:









- Unique integral DIN-rail adapters for 600V, 30 & 60A blocks
- Full barrier design (30 & 60A) increases pole to pole safety
- Unique adder-block design (30 & 60A) for design flexibility
- Spring reinforcing standard for all 30 & 60A clips
- Features high conductivity copper alloy fuse clips
- Cool running high amperage (100 - 600A) connectors
- Copper connectors available 30 - 600A

Recommended Fuse Usage:

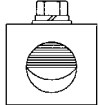
Class T Blocks (300V) use with A3T

Class T Blocks (600V) use with A6T

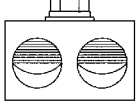
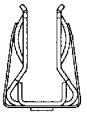
Clip & Connector Types

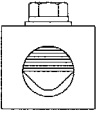
Spring Reinforced 30A & 60A Clips	Connectors for Spring Reinforced 30A & 60A Clips	Connectors	Connectors
300V - 30A 600V - 30A 	30A - 60A Box 	100A Box Side Clip 	400A Box 
300V - 60A 	30A - 60A Screw 	100A Box 	600A Box 
600V - 60A 	30A - 60A Pressure Plate 	200A Box 	



Ratings:

Volts : 300VAC / DC

: 600VAC / DC

Amps : 30A, 60A, 100A, 200A,
400A, 600A

SCCR : 200kA

Approvals:

- All fuse blocks meet the requirements of UL 4248
- UL listed, guide IZLT, File E52283
- UL recognized component guide IZLT2, file E52283
- CSA certified class 6225, File 32169



Shah & Shah Enterprise

www.shahent.co.in

CLASS T 300 & 600 Volt Fuse Blocks

300 Volt, 30 & 60 Ampere Class T Fuse Blocks

Ampere Rating	Poles	Connector		Catalog No. Spring Reinforced	Fig.	Connector Torque In - lb
		Type	Wire Range			
30 GFPC Insulator	ADDER	Box	Al/Cu #2-14	30305T	1	35
	1			30306T	2	
	2			30307T	3	
	3			30308T	4	
	4			30309T	5	
	ADDER	Screw	Cu #10-14	30315T	1	20
	1			30316T	2	
	2			30317T	3	
	3			30318T	4	
	4			30319T	5	
	ADDER	Pressure Plate	Cu #10-14	30325T	1	20
	1			30326T	2	
	2			30327T	3	
	3			30328T	4	
	4			30329T	5	
	ADDER	Box	Cu* #4-14	30355T	1	35
	1			30356T	2	
	2			30357T	3	
	3			30358T	4	
	4			30359T	5	
ADDER	Screw	Cu #10-14	30615T**	1	20	
1			30616T**	2		
2			30617T**	3		
3			30618T**	4		
4			30619T**	5		
60 GFPC Insulator	ADDER	Box	Al/Cu #2-14	30605T	1	45
	1			30606T	2	
	2			30607T	3	
	3			30608T	4	
	4			30609T	5	
	ADDER	Box	Cu* #4-14	30655T	1	45
	1			30656T	2	
	2			30657T	3	
	3			30658T	4	
	4			30659T	5	

*Fuse blocks have copper box connectors and clips and are for copper wires only. These are specifically designed with the same coefficient of expansion as copper wire for improved heat cycling and meet or exceed OEM "no aluminum" specifications.

** UL Component Recognized

Recommended base mounting screws: #10 (.190" dia.)

Dimensions

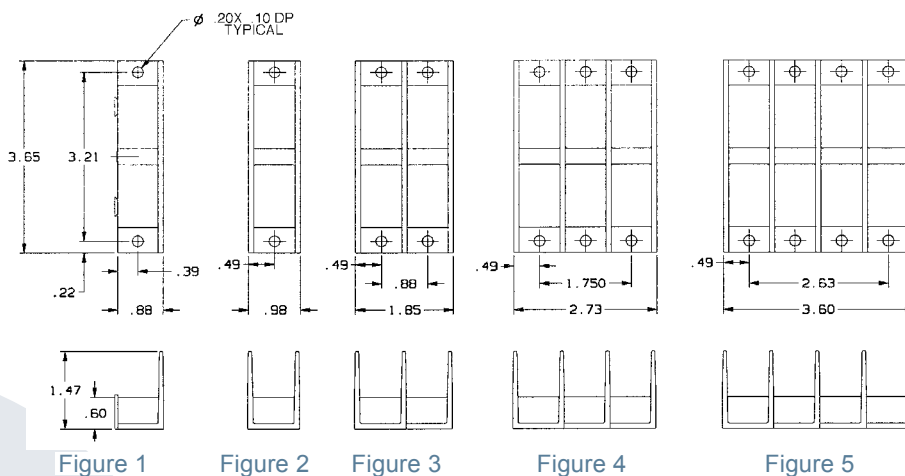

CLASS T 300 & 600 Volt Fuse Blocks

300 Volt, 100, 200, 400 & 600 Ampere Class T Fuse Blocks

Ampere Rating	Poles	Connector		Catalog No.	Fig.	Connector Torque In - lb	
		Type	Wire Range			Connector	Fuse Bolt
100 Phenolic Insulator	1	Box	Cu*	31001T	1	50	72
	2		2/0-#12	31002T	2		
	3			31003T	3		
200 Phenolic Insulator	1	Box	Al/Cu	32031T	4	275	132
	3		350 kcmil-#6	32033T	5		
	1		Cu*	32051T	4		
400 Phenolic Insulator	3	Box	350 kcmil-#6	32053T	5	600	228
	1		Al/Cu	34031T	6		
	3		600 kcmil-#2	34033T	7		
600 Phenolic Insulator	1	Box	Cu*	34051T	6	375	228
	3		600 kcmil-#2	34053T	7		
	1		Al/Cu	36031T	8		
1	Box	Cu*	36051T	8			
			(2) 600 kcmil-#2				
			Cu*				
			(2) 600 kcmil-#2				

† Note: Height includes nominal fuse blade thickness

Recommended base mounting screws:

100A & 200A, #10 (.190" dia.)

400A & 600A, 1/4" (.250" dia.)

Note: * Fuse blocks have copper box connectors and are for copper wires only. These are specifically designed with the same coefficient of expansion as copper wire for improved heat cycling and meet or exceed OEM "no aluminum" specifications.

Dimensions

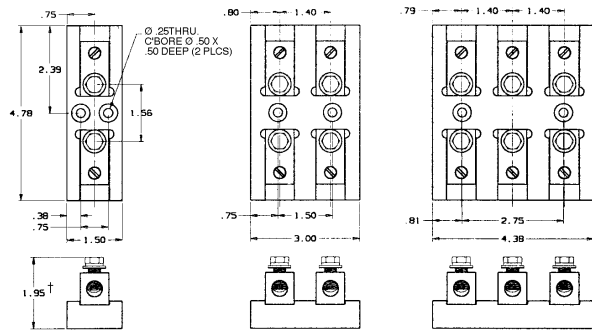

Figure 1

Figure 2

Figure 3

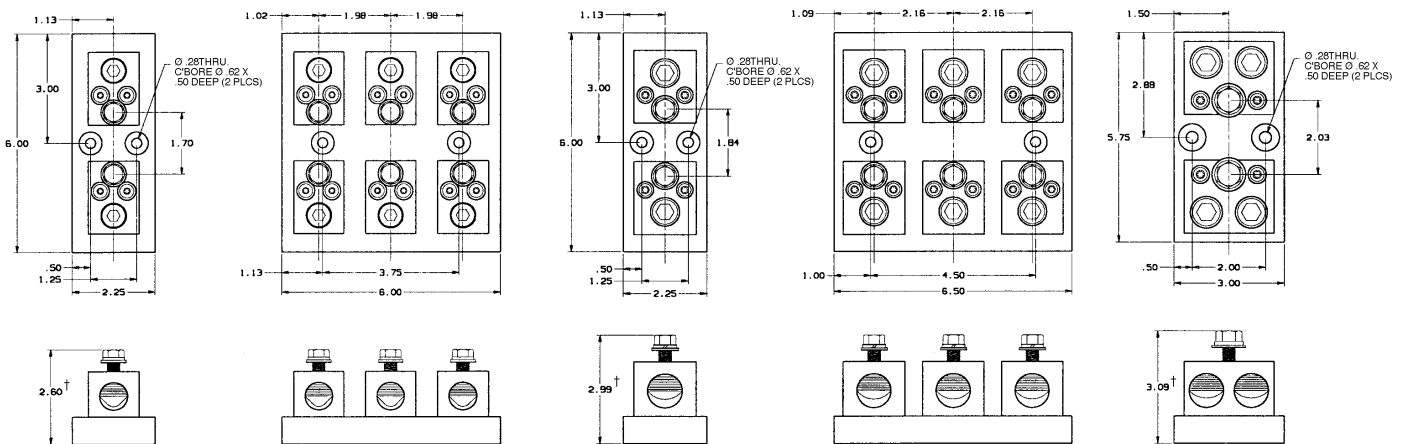

Figure 4

Figure 5

Figure 6

Figure 7

Figure 8



Shah & Shah Enterprise

www.shahent.co.in

CLASS T 300 & 600 Volt Fuse Blocks

600 Volt, 30 & 60 Ampere Class T Fuse Blocks

Ampere Rating	Poles	Connector		Catalog No.	Fig.	Connector Torque In - lb
		Type	Wire Range			
30 GFPC Insulator	ADDER			60305T	1	
	1	Box	Al/Cu #2-14	60306T	2	35
	2			60307T	3	
	3			60308T	4	
	ADDER				60315T	
	1	Screw	Cu #10-14	60316T	2	20
	2			60317T	3	
	3			60318T	4	
	ADDER				60325T	
	1	Pressure Plate	Cu #10-14	60326T	2	20
	2			60327T	3	
	3			60328T	4	
	ADDER				60355T	
	1	Box	Cu* #4-14	60356T	2	35
	2			60357T	3	
3	60358T			4		
60 GFPC Insulator	ADDER					
	1	Screw	Cu #10-14	60616T**	6	20
	2			60617T**	7	
	3			60618T**	8	
	ADDER				60605T	
	1	Box	Al/Cu #2-14	60606T	6	45
	2			60607T	7	
	3			60608T	8	
	ADDER				60655T	
	1	Box	Cu* #4-14	60656T	6	45
	2			60657T	7	
	3			60658T	8	

*Fuse blocks have copper box connectors and clips and are for copper wires only. These are specifically designed with the same coefficient of expansion as copper wire for improved heat cycling and meet or exceed OEM "no aluminum" specifications.

** UL Component Recognized

Recommended mounting screws:
30A, #10 (.190" dia.)
60A, 1/4 " (.250" dia.)

Dimensions

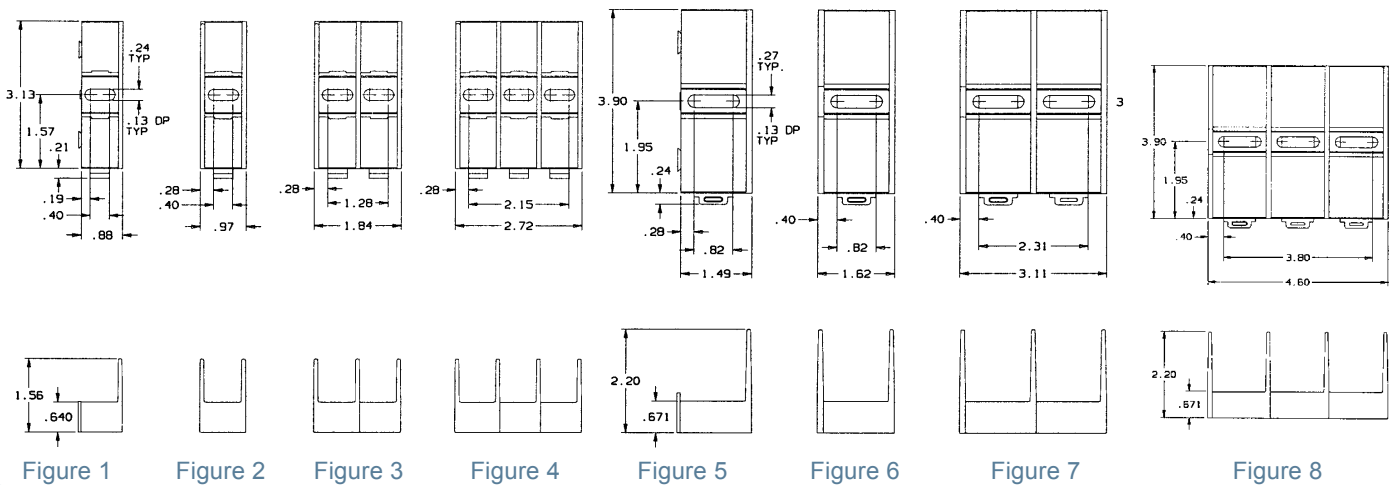

CLASS T 300 & 600 Volt Fuse Blocks

600 Volt, 100, 200, 400 & 600 Ampere Class T Fuse Blocks

Ampere Rating	Poles	Connector		Catalog No. Spring Reinforced	Fig.	Torque (In - Lbs)	
		Type	Wire Range			Connector	Fuse Bolt
100	1	BOX	Al/Cu 2/0-#6	61031T	1	120	72
	2			61032T	2		
	3			61033T	3		
Phenolic Insulator	1	BOX	Cu* 2/0-#12	61051T	1	50	72
	2			61052T	2		
	3			61053T	3		
200	1	BOX	Al/Cu 350 kcmil-#6	62031T	4	275	132
	3			62033T	5		
	Phenolic Insulator			1	BOX		
3	62053T	5					
400	1	BOX	Al/Cu 600 kcmil-#2	64031T	6	600	228
	Phenolic Insulator			1	BOX		
600	1	BOX	Al/Cu (2) 600 kcmil-#2	66031T		7	600
	Phenolic Insulator			1	BOX	Cu* (2) 600 kcmil-#2	

Note: Fuse blocks have copper box connectors and are for copper wires only. These are specifically designed with the same coefficient of expansion as copper wire for improved heat cycling and meet or exceed OEM "no aluminum" specifications.

Recommended base mounting screws:
100A & 200A, #10 (.190" dia.)
400A & 600A, 1/4" (.250" dia.)

Dimensions

