

MULTIVERT® 250A

Size 1, 690VAC

IEC FUSE SWITCH DISCONNECTORS

NH VERTICAL FUSE SWITCH DISCONNECTOR



MULTIVERT® NH vertical fuse switch disconnectors meet all functions of NH fuse switch disconnectors. They are designed for installation on to bus bars in triple pole arrangements.

MULTIVERT® 250A are for installation on to 185mm bus bar systems.

MULTIVERT® 250A are designed for NH fuse-links in accordance with IEC/EN 60269-2, VDE 0636-2, size 1: 250A.

The system is a modular system, that allows the installation of individual components. MULTIVERT® offer the user the possibility of fast and easy installation as well as a high degree of protection during installation and maintenance.

TECHNICAL DATA OVERVIEW

Voltage AC	690 VAC
Amper (A)	250 A
Size per Standard	1
SCCR	Ue = AC 400 V; Ie = 250 A 120kA Ue = AC 500 V; Ie = 250 A 120kA Ue = AC 690 V; Ie = 250 A 120kA
Mounting	bus bar system 185 mm
Switchability	1 x triple pole, 3 x single pole
Number of Poles	3

FEATURES & BENEFITS

- Installation on to 185mm bus bar system
Standard design with M 12 screws: M = 35 ±3Nm
Direct installation without drilling with hooked clamps possible
- Symmetrical switch - top/bottom cable terminal connection
- Touch protection IP 30 with central cover
- Varieties of cable termination: bolt, insert nut, V-terminal
- Integrated measuring transformer (optional) with unchanged installation depth
- Safe on load connection/disconnection in accordance with IEC 60947-3

APPLICATIONS

- Feeder pillars
- Transformer substations
- Switch boards for industrial applications
- Residential and industrial distribution units
- Cable distribution cabinets

STANDARDS

- IEC/EN 60 947-3
For NH-fuse links size 1 in accordance with IEC/EN 60 269-2, VDE 0636-2



MULTIVERT® 250A

Size 1, 690VAC

PRODUCT RANGE



1.150.000 1.170.000

MULTIVERT® 250 A size 1 185 mm 1 x triple pole switching

Catalog number	Item number	Cable termination components	Design	Weight kg ¹	Package
1.150.000	L1002189	3 M10 bolts	-	4.67	1 piece
1.160.000	S1023171	3 M10 insert nuts	-	4.63	1 piece
1.170.000	H1023185	V-terminal for V-terminal clamps size 1,2,3	-	4.55	1 piece
1.170.600	K1023187	V-terminal with 3 terminal clamps size 1,2,3	-	4.60	1 piece
1.170.900	M1023189	V-terminal, 2 terminals per phase for V-terminal clamps size 1,2,3	-	5.80	1 piece
1.150.100	P1002192	3 M10 bolts	MULTIVERT® 1.150.000 with cabling of instrument leads for indication facilities	5.10	1 piece
1.150.083	R1023193	3 M10 bolts	MULTIVERT® 1.150.000 with integrated C.T. 250/5A, 3,75 VA, class 1 for single pole measurement (ready fitted in pole 1)	4.80	1 piece
1.150.062	N1023190	3 M10 bolts	MULTIVERT® 1.150.000 with integrated C.T. 250/5A, 3,75 VA, class 0,5; calibrated, for single pole measurement (ready fitted in pole 1)	-	1 piece
1.150.091	S1023194	3 M10 bolts	MULTIVERT® 1.150.000 with integrated C.T. 100/5A, 2,00 VA, class 1 for triple pole measurement	5.40	1 piece
1.150.093	T1023195	3 M10 bolts	MULTIVERT® 1.150.000 with integrated C.T. 250/5A, 3,50 VA, class 1 for triple pole measurement	5.40	1 piece
1.150.072	P1023191	3 M10 bolts	MULTIVERT® 1.150.000 with integrated C.T. 250/5A, 3,50 VA, class 0,5; calibrated, for triple pole measurement	-	1 piece

¹weight in kg per piece or set including package

MULTIVERT® 250 A size 1 185 mm 3 x single pole switching



1.100.000 1.120.000

Catalog number	Item number	Cable termination components	Design	Weight kg ¹	Package
1.100.000	H1002186	3 M10 bolts	-	4.52	1 piece
1.110.000	J1023163	3 M10 insert nuts	-	4.46	1 piece
1.120.000	K1023164	V-terminal for V-terminal clamps size 1,2,3	-	4.38	1 piece
1.120.900	Q1023169	V-terminal, 2 terminals per phase for V-terminal clamps size 1,2,3	-	5.50	1 piece
1.100.083	N1023167	3 M10 bolts	MULTIVERT® 1.100.000 with integrated C.T. 250/5A, 3,75 VA, class 1 for single pole measurement (ready fitted in pole 1)	4.60	1 piece
1.100.062	L1023165	3 M10 bolts	MULTIVERT® 1.100.000 with integrated C.T. 250/5A, 3,75 VA, class 0,5; calibrated, for single pole measurement (ready fitted in pole 1)	-	1 piece
1.100.093	P1023168	3 M10 bolts	MULTIVERT® 1.100.000 with integrated C.T. 250/5A, 3,50 VA, class 1 for triple pole measurement	5.30	1 piece
1.100.072	M1023166	3 M10 bolts	MULTIVERT® 1.100.000 with integrated C.T. 250/5A, 3,50 VA, class 0,5; calibrated, for triple pole measurement	-	1 piece

¹weight in kg per piece or set including package

MERSEN reserves the right to change, update or correct, without notice, any information contained in this datasheet.



Shah & Shah Enterprise

www.shahent.co.in

MULTIVERT® 250A

Size 1, 690VAC

TECHNICAL DATA IN ACCORDANCE WITH EN / IEC 60947

	250 A 1 x triple pole switching	250 A 3 x single pole switching
Number of poles/phases	3	3
Size	1	1
Conventional free air thermal current with NH-fuse links I_{th}	250 A	250 A
Max. power dissipation of fuse links P_n	23 W	23 W
Conventional free air thermal current with solid links I_{th}	400 A	400 A
Max. power dissipation of solid links P_n	2,6 W	2,6 W
Utilization category to IEC/EN 60947-3 $U_e = AC 400 V; I_e = 250 A$ $U_e = AC 500 V; I_e = 250 A$ $U_e = AC 690 V; I_e = 250 A$	AC 23 B AC 23 B AC 22 B	AC 23 B AC 23 B AC 22 B
Rated operational voltage U_e	690 V	690 V
Rated insulation voltage U_i	1000 V	1000 V
Rated impulse withstand voltage U_{imp}	12 kV	12 kV
Rated frequency	50 ... 60 Hz	50 ... 60 Hz
Degree of protection	IP 30	IP 30
Degree of pollution	3	3
Rated duty	uninterrupted duty	uninterrupted duty
Rated conditional short-circuit current with fuse links $U_e = AC 400 V; I_e = 250 A$ $U_e = AC 500 V; I_e = 250 A$ $U_e = AC 690 V; I_e = 250 A$	120 kA 120 kA 120 kA	120 kA 120 kA 120 kA
Rated short circuit making capacity with solid links I_{cm}	16 kA _{sw}	16 kA _{sw}
Rated short-time withstand current I_{cw}	8 kA / 1 s	8 kA / 1 s
Power dissipation by I_{th} without NH-fuse links	35 W	35 W
Power dissipation by I_{th} 400A without solid links	90 W	90 W
Installation mode	bus bar installation	bus bar installation
Cable terminal connection		
Standard cable terminal	M10	M10
for cable lugs Cu max.	300 mm ²	300 mm ²
for cable lugs Al max.	300 mm ²	300 mm ²
for copper bars with max. dimensions	40 x 10 mm	40 x 10 mm
V-shaped lugs for V-terminal clamps	35 - 240 mm ²	35 - 240 mm ²
Bus bar terminal connection		
Standard bus bar terminal	M12	M12
Hooked clamp for bus bar with thickness	5 ... 10 mm	5 ... 10 mm
Bus bar system	185 mm	185 mm



MULTIVERT® 250A

Size 1, 690VAC

DIMENSIONS

MULTIVERT® 250A, 400A, 630A NH-vertical fuse switch disconnecter, 3 x single pole switching
direct installation with screws on to 185mm bus bar system

(M01152b)

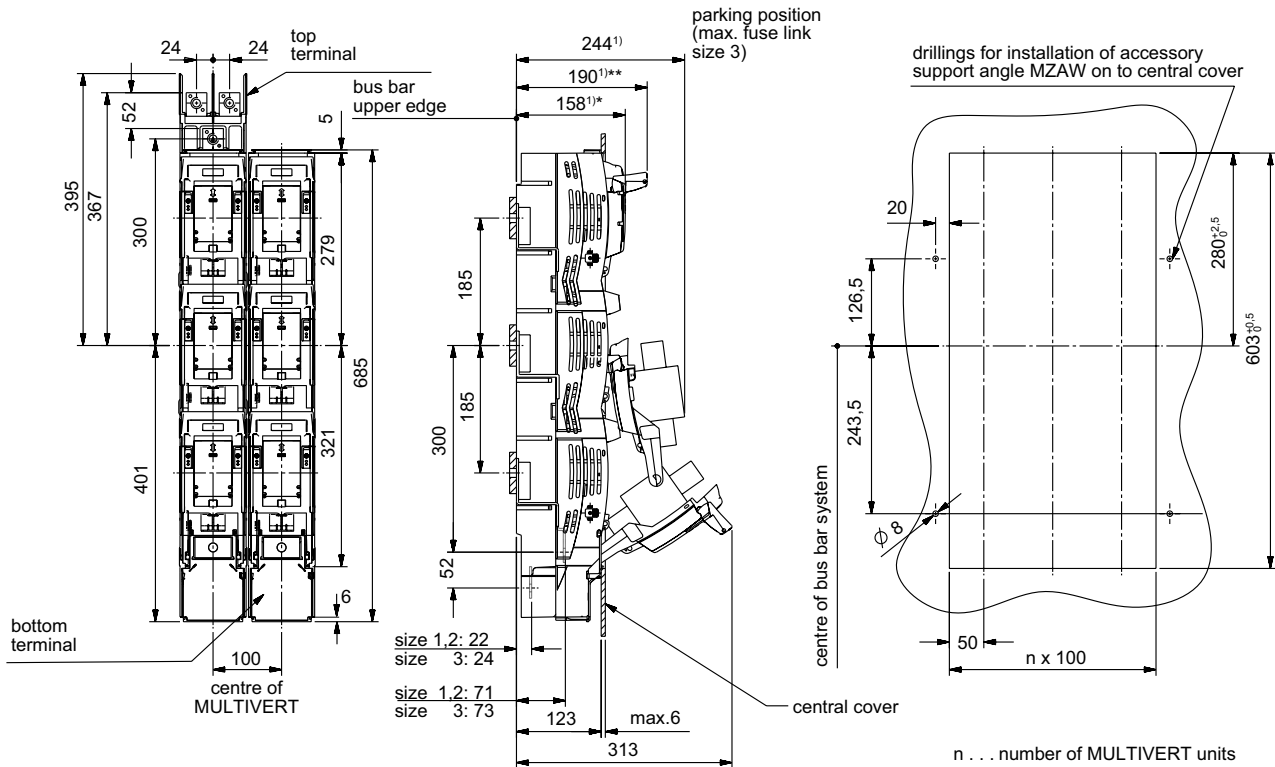

1) dimension from upper edge of bus bar

- * 158 mm handle in closed position (folded) = total installation depth of MULTIVERT
- ** 190 mm handle in open position (fixed) = switching position

Dimensions in mm

MULTIVERT® 250A, 400A, 630A NH-vertical fuse switch disconnecter, 1 x triple pole switching
direct installation with screws on to 185mm bus bar system

(M01153b)

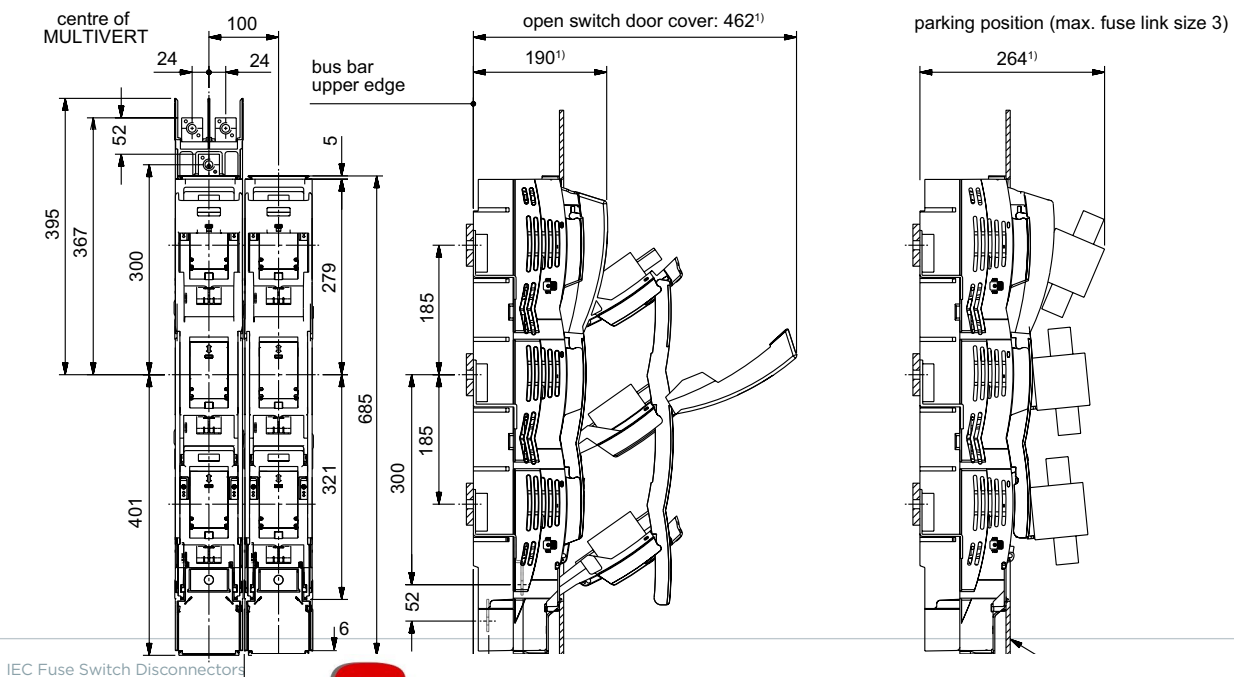

IEC Fuse Switch Disconnectors



Shah & Shah Enterprise

www.shahent.co.in

MULTIVERT® 250A

Size 1, 690VAC

DIMENSIONS

MULTIVERT® 250A, 400A, 630A NH-vertical fuse switch disconnecter, 3 x single pole switching
direct installation without drilling with hooked clamps on to 185mm bus bar system

(M01154b)

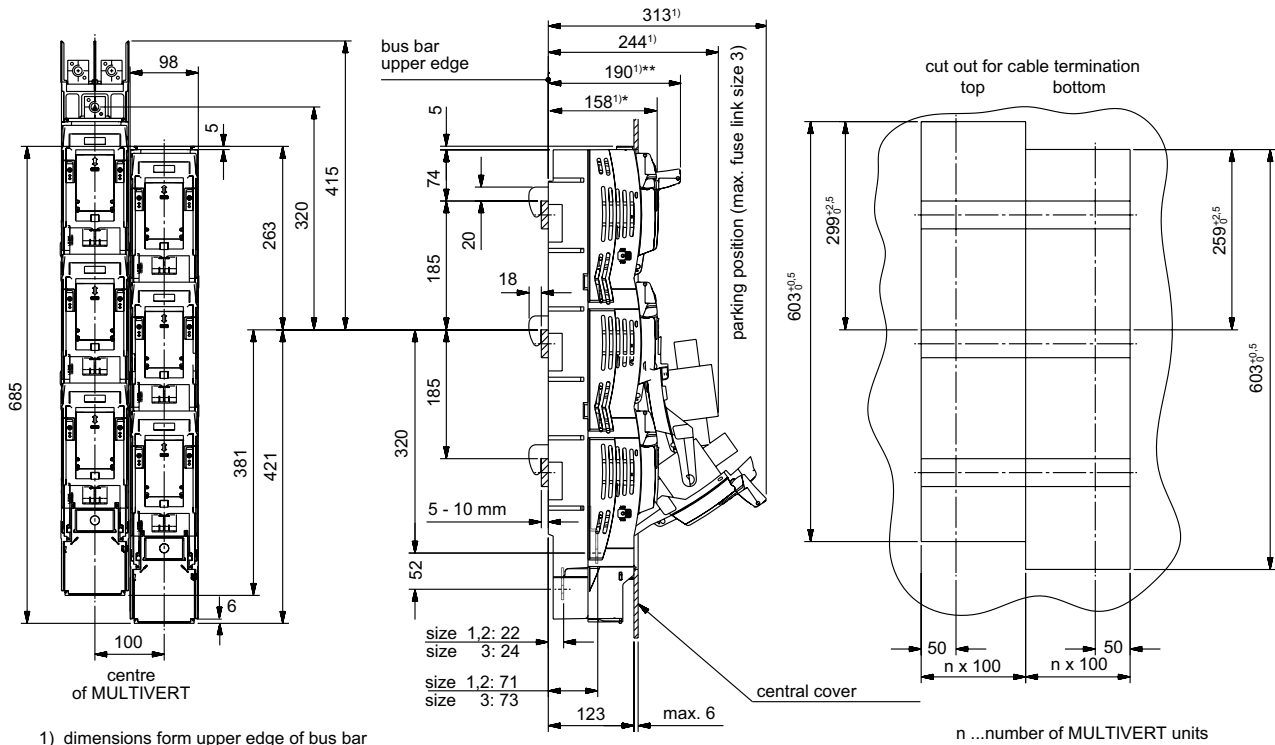

Dimensions in mm

MULTIVERT® 250A

Size 1, 690VAC

DIMENSIONS

Cable termination MULTIVERT® 250A, 400A, 630A (M01105b)

reference	B	E	V	
type of terminal	bolt	insert nut	V-terminal	
accessory	cable lug max. width 45 mm	cable lug max. width 45 mm	V-clamp (accessory) 22SZVK4 22SZVK41	
cross section [mm²]	max. 300	max. 300	50 - 240 sectoral solid 50 - 185 sectoral stranded 35 - 70 round stranded 35 - 50 round solid	95 - 300 sectoral solid 70 - 240 sectoral stranded 50 - 185 round stranded 70 - 240 round solid
M [Nm]	35 ±3	35 ±3	25 ±2	25 ±2

Dimensions in mm

MULTIVERT® 250A

Size 1, 690VAC

DIMENSIONS

Cable termination MULTIVERT® 250A, 400A, 630A multiple termination (M01156a)

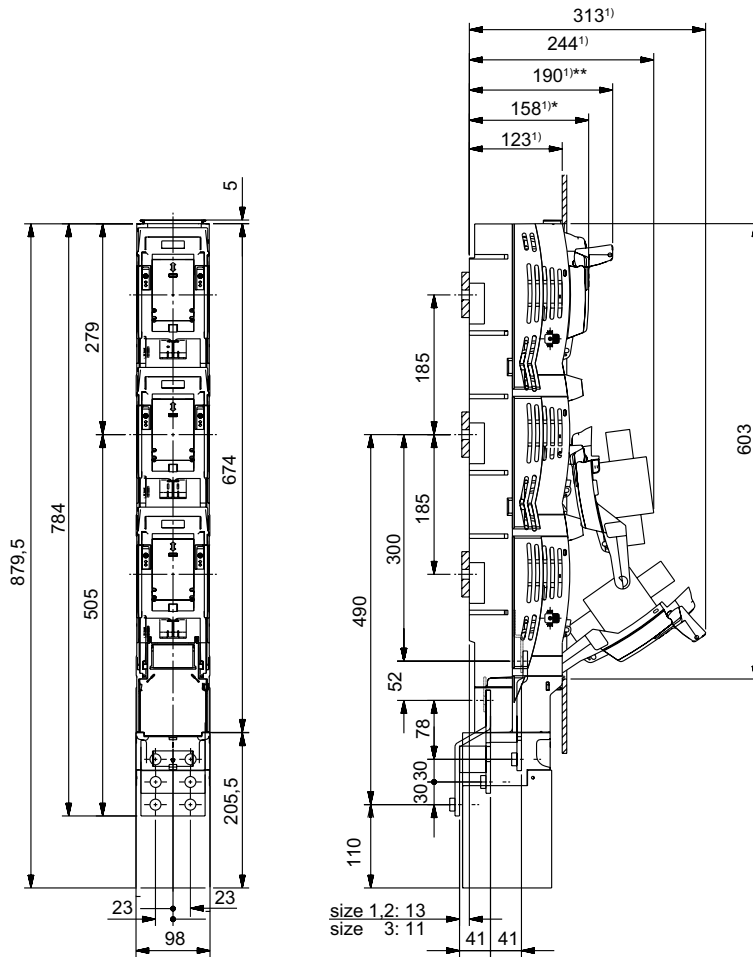

1) dimensions form upper edge of bus bar

- * 158 mm handle in closed position (folded) = total installation depth of MULTIVERT
- ** 190 mm handle in open position (fixed) - switching position

Dimensions in mm

MULTIVERT® 250A

Size 1, 690VAC

DIMENSIONS

Cable termination MULTIVERT® 250A, 400A, 630A multiple termination (MA88f)

terminal: 2 cable lugs

Cu: up to max. 300 mm² round stranded, sectoral stranded cable lugs in accordance with DIN 46235
Al: up to max. 300 mm² round stranded, sectoral stranded cable lugs in accordance with DIN 46329
M: 32-38 Nm

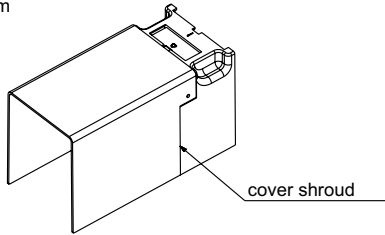

cable lugs in accordance with DIN 46235 and DIN 46329 max. width 46 mm

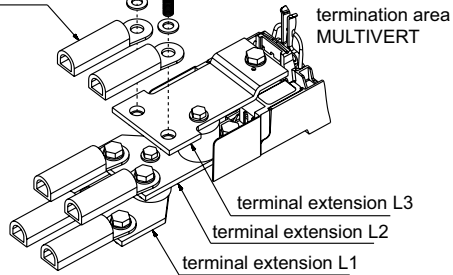

NOTE:
Due to safety precautions we suggest to insulate the cable lugs (185, 240 und 300 mm²).

terminal: 3 cable lugs

Cu: up to max. 150 mm² round stranded, sectoral stranded cable lugs in accordance with DIN 46235
M: 32-38 Nm

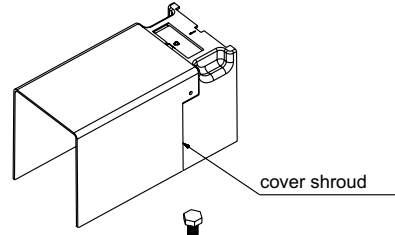

cable lug in accordance with DIN 46235

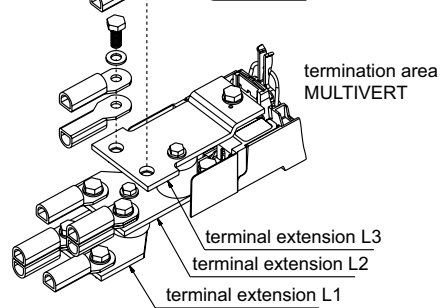

NOTE:
Due to safety precautions we suggest to insulate the cable lugs (95, 120 und 150 mm²).

Position of terminals

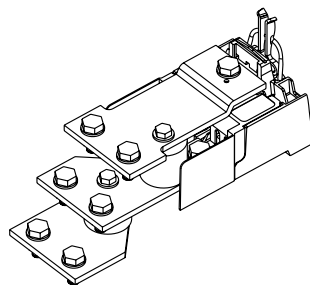

tightening torque of screws: 32 - 38 Nm

Dimensions in mm

MULTIVERT® 250A

Size 1, 690VAC

DIMENSIONS

Cover shrouds for cable termination bottom terminal MULTIVERT® 250A, 400A, 630A (M01160a-1)

standard design: integrated shroud for bottom cable termination

for terminal connections with cable lugs (bolt and insert nut)
- on switch boards with central cover

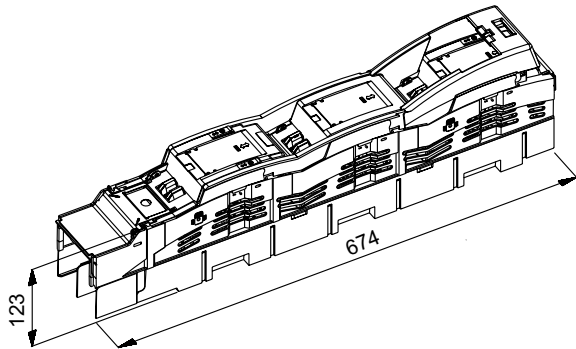

for clamp terminal connections (V-terminal)
for special "high" clamp terminal connections (double V-clamps)
- on switch boards with central cover
and in feeder pillars

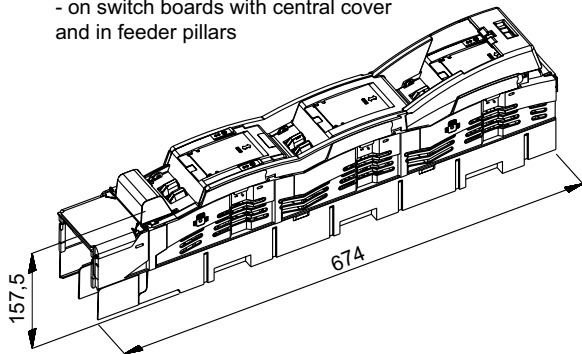

Extension shroud for bottom cable termination article number 1.002.095 (accessory)

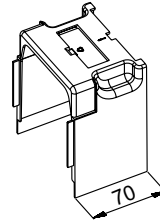

for extended cover
for terminal connections with cable lugs (bolt and insert nut)
- on switch boards with central cover

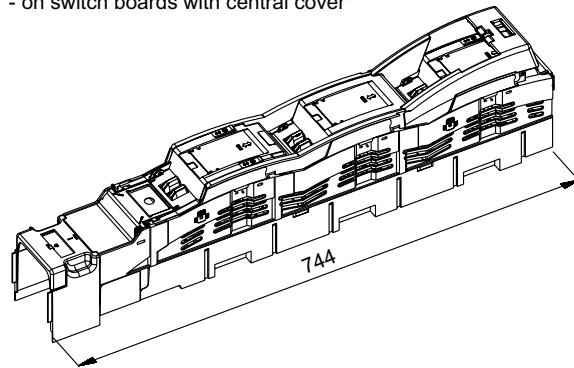

for extended cover
for clamp terminal connections (V-terminal)
for special "high" clamp terminal connections (double V-clamps)
- on switch boards with central cover
and in feeder pillars

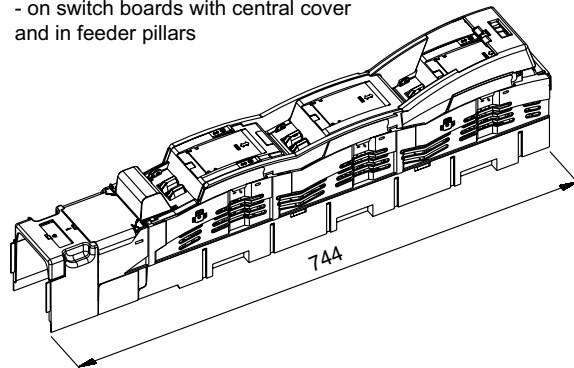

Dimensions in mm



MULTIVERT® 250A

Size 1, 690VAC

DIMENSIONS

Cover shrouds for cable termination bottom terminal MULTIVERT® 250A, 400A, 630A multiple termination

(M01160b-2)

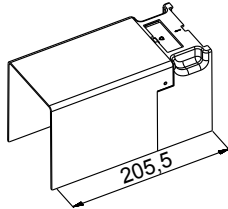

catalogue no. 1.002.458 - accessory

for application multiple termination
for cable termination with 2 or 3 cable lugs/phase
see MA 88
- on switch boards with cover shroud

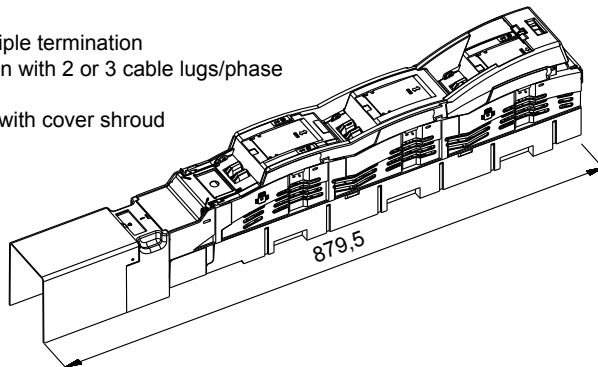

for application multiple termination
for V-terminal: terminal lugs: 2 terminals per phase with V-clamp
- on switch boards with central cover
and in feeder pillars

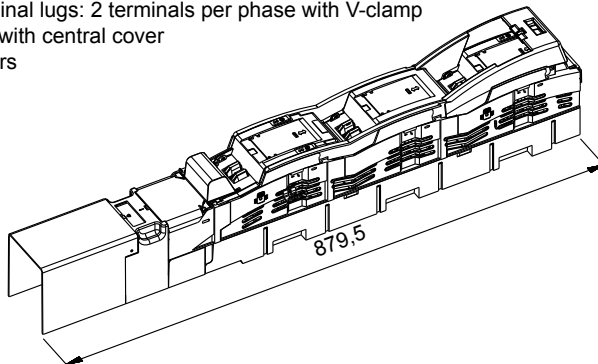

Dimensions in mm

MULTIVERT® 250A

Size 1, 690VAC

DIMENSIONS

Cover shrouds for cable termination top terminal MULTIVERT® 250A, 400A, 630A (M01160a-3)

without shroud for cable termination

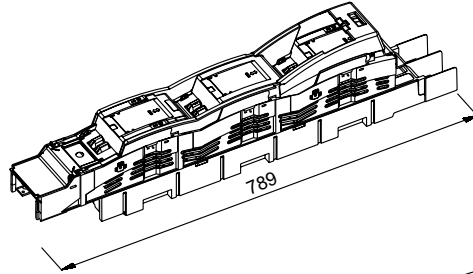

shroud for top cable termination
article number: MZKHO (accessory)
for terminal connections with
cable lugs (bolt and insert nut)
- on switch boards with central cover

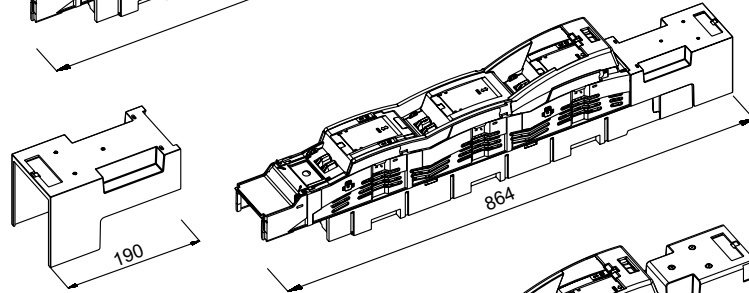

shroud for top cable termination
article number: MZKAB (accessory)
for clamp terminal connections
(V-terminal)
- in feeder pillars

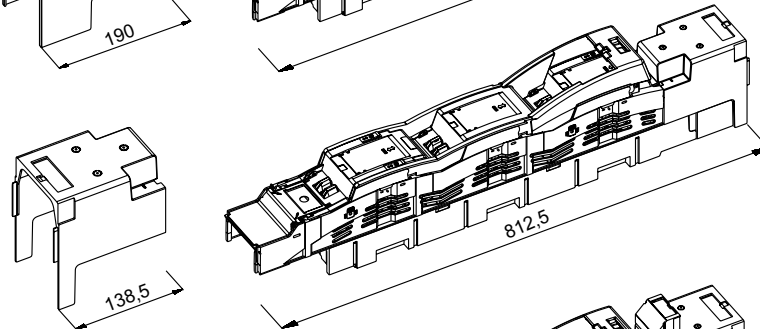

shroud for top cable termination
article number: MZKAB1 (accessory)
for special "high" clamp terminal
connections (double V-clamps)
- in feeder pillars

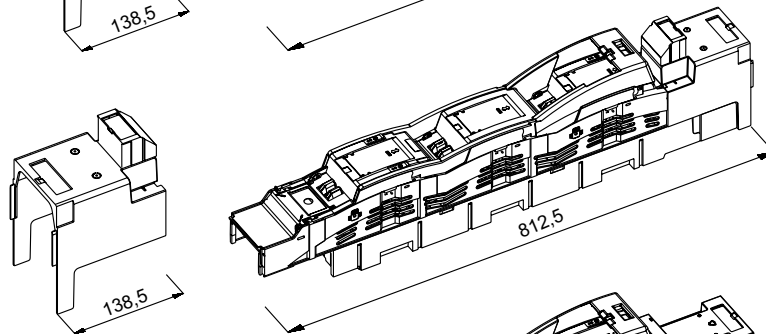

shroud for top cable termination
article number: MZKHV (accessory)
for terminal connections with cable lugs
for installation in distribution units
with central cover

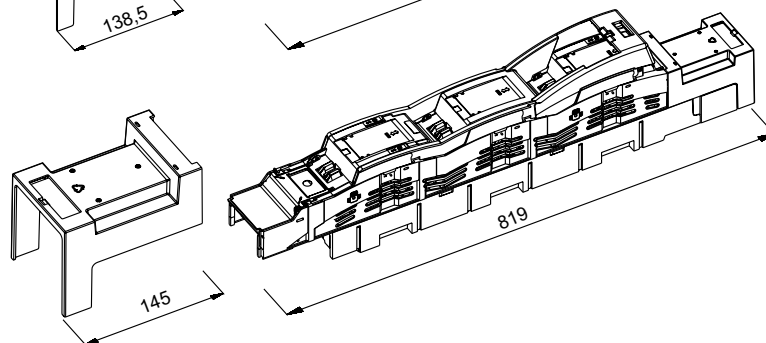

Dimensions in mm

MULTIVERT® 250A

Size 1, 690VAC

EXPLODED SKETCH

MULTIVERT® 250A, 400A, 630A 3x single pole switching (E 1.002.265a)

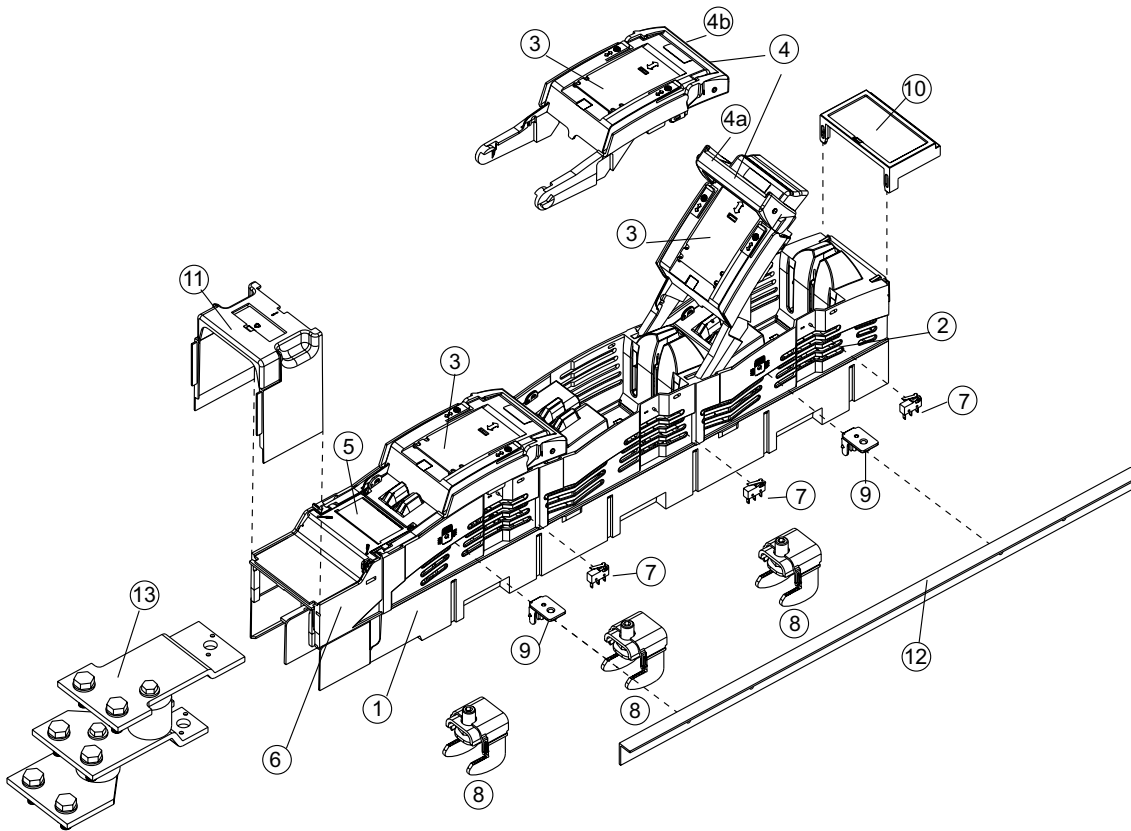

no.	articlenumber	short Description
1		Main base
2		Protection cover (removable)
3		Switch operating cover triple pole
4		Combination handle: 4a. open - switching position; 4b. Closed - installation depth 158mm
5		Labelling area (label)
6		Integrated cover shroud
7	1.000.852	indicator for switch door position
8	1.000.192	Hooked clamp, 1 set = 3 pieces
9	MZAW	Support angle, 1 set = 4 pieces
10	MZBT	Label holder
11	1.002.095	Cover shroud, bottom terminal, 70mm
12	1.001.510	cover shield, length 605mm, set=2 pieces
13	1.002.255	Supplementary set for multiple terminal

MERSEN reserves the right to change, update or correct, without notice, any information contained in this datasheet.



Shah & Shah Enterprise

www.shahent.co.in

MULTIVERT® 250A

Size 1, 690VAC

EXPLODED SKETCH

MULTIVERT® 250A, 400A, 630A 1x triple pole switching (E 1.002.266)

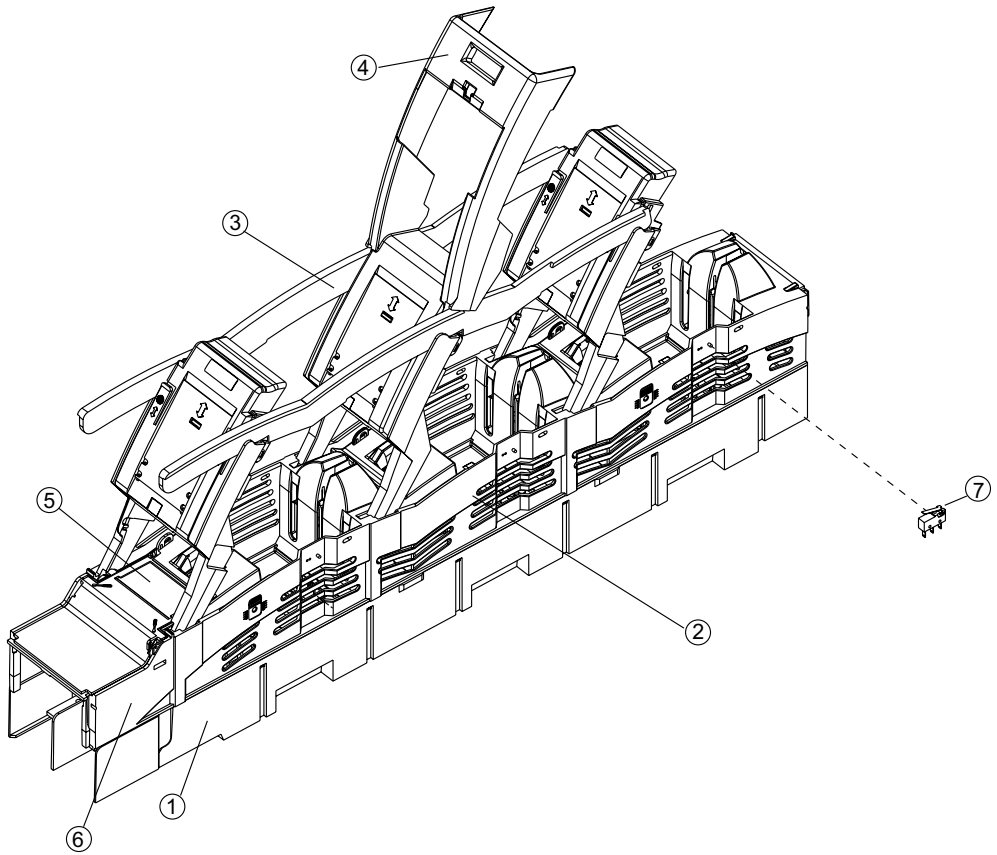

no.	articlenumber	short Description
1		Main base
2		Protection cover (removable)
3		Switch operating cover triple pole
4		Handle
5		Labelling area (label)
6		Integrated cover shroud
7	1.000.852	indicator for switch door position

MERSEN reserves the right to change, update or correct, without notice, any information contained in this datasheet.

MULTIVERT® 250A

Size 1, 690VAC

ACCESSORIES



1.002.095



1.002.458



MZKAB



MZKHO



MZKAB1



MZVHB



MZKHV



1.001.510



MZAW

Cover/shrouds for cable termination

Catalog number	Item number	Weight	Design	Application	Weight	Package
1.002.095	J1002279	0.116 kg	cover shroud for extended cover length 70 mm	bottom terminal	0.116 kg	1 piece
1.002.458	N1023305	0.164 kg	cover shroud for multiple termination length 205,5mm	bottom terminal	0.164 kg	1 piece
MZKAB	J1023301	0.174 kg	cover shroud for clamp terminal connection in feeder pillars length 138,5 mm	top terminal	0.101 kg	1 piece
MZKHO	G217655	0.126 kg	cover shroud for cable terminal connections with cable lugs on switchboards with central cover length 190 mm	top terminal	0.126 kg	1 piece
MZKAB1	K1023302	0.115 kg	cover shroud for special (high) clamp terminal connection in feeder pillars length 138,5 mm	top terminal	0.115 kg	1 piece
MZVHB	L1023303	0.225 kg	extended cover shroud length 257 mm	top terminal	0.225 kg	1 piece
MZKHV	A1002202	85 g	cover shroud for installation in distribution units with central cover (height of supporting edge reduced by 16 mm) length 145 mm	top terminal	85 g	1 piece

Covers/level & system adjustment covers

Catalog number	Item number	Weight	Design	Weight	Package
1.001.510	K1002280	0.15 kg	cover shield to support central cover 1 set = 2 pieces	0.15 kg	1 set
MZAW	D218687	27 g	support angle for support of cover plate 1 set = 4 pieces	0.027 kg	1 set

MERSEN reserves the right to change, update or correct, without notice, any information contained in this datasheet.

MULTIVERT® 250A

Size 1, 690VAC

ACCESSORIES



MZO1LPAP

MZLPAP

1.002.493



1.002.492

1.002.830

1.002.829



1.002.647



1.000.192

Covers/spare way covers

Catalog number	Item number	Weight	Design	Application	Weight	Package
MZO1LPAP	C1023410	60 g	spare way cover without level adjustment width 50 mm, length 500 mm including fixing material	bus bar system 185 mm	60 g	1 piece
MZLPAP	D1023411	0.56 kg	spare way cover width 100 mm, length 612 mm including 2 pieces M12 fixing screws (distance of fixing holes 185 mm)	bus bar system 185 mm	0.56 kg	1 piece
1.002.493	N1002283	0.136 kg	spare way cover width 50 mm, length 630 mm for covering of open installation spaces in distribution units with central cover	bus bar system 185 mm	0.136 kg	1 piece
1.002.492	M1002282	0.202 kg	spare way cover width 100 mm, length 630 mm for covering of open installation spaces in distribution units with central cover	bus bar system 185 mm	0.202 kg	1 piece
1.002.830	E1023412	0.203 kg	spare way cover width 50 mm, length 630 mm with level adjustment 123 mm for bus bar installation, set = cover + fixing set (2 distance pieces, 2 screw rivets)	bus bar system 185 mm	0.203 kg	1 set
1.002.829	F1023413	0.33 kg	spare way cover width 100 mm, length 630 mm with level adjustment 123 mm for bus bar installation set = cover + fixing set (2 distance pieces, 2 screw rivets)	bus bar system 185 mm	0.27 kg	1 set

Installation devices/bus bar installation

Catalog number	Item number	Weight	Design	Weight	Package
1.002.647	S1023447	-	M10 insert nut, size 1 1 set = 30 pieces	0.19 kg	1 set
1.000.192	P1002284	0.467 kg	hooked clamp size 1, 2, 3, M = 15–20 Nm hexagon socket connection (inbus) for MULTIVERT®/BSL with top or bottom terminal 1 set = 3 pieces	0.467 kg	1 set



MULTIVERT® 250A

Size 1, 690VAC

ACCESSORIES



1.002.940

MZESM



1.000.829

1.000.852



1.000.102



MZPR600



MZBT

Indication facilities

Catalog number	Item number	Weight	Design	Weight	Package
1.002.940	Z1023453	0.159 kg	electronic fuse monitoring ESÜ size 1,2,3 for MULTIVERT® 250 A, 400 A, 630 A with cabling of instrument leads (rated voltage 525VAC)	0.85 kg	1 piece
MZESM	J228766	0.104 kg	Electronic System Monitor ESM size 1,2,3 for MULTIVERT® 250 A, 400 A, 630 A with cabling of instrument leads	0.104 kg	1 piece
1.000.829	L1023418	0.314 kg	electro-mechanical fuse monitoring (galvanic isolation) MZS size 1,2,3 for MULTIVERT® 250 A, 400 A, 630 A with cabling of instrument leads	0.314 kg	1 piece
1.000.852	Q1002285	9 g	indicator for switch door position micro switch, 1 change-over contact 5 A, 250 V	0.09 kg	1 piece

Amperemeter units

Catalog number	Item number	Weight	Design	Weight	Package
1.000.102	M1023281	0.44 kg	size 1, 2, 3, 250 A, with drag indicator, single pole measurement	83 g	1 piece
1.000.108	T1023287	0.44 kg	size 1, 2, 3, 250 A, with drag indicator, triple pole measurement (optional L1, L2, L3)	83 g	1 piece

Current transformers/external current transformers

Catalog number	Item number	Weight	Design	Weight	Package
MZ1SW250	K1024567	0.88 kg	current transformer up to 250/5A for single pole measurement, class 1 set = 1 piece current transformer + 3 pieces distance tubes for level adjustment, 1 piece installed in the current transformer, 2 pieces additionally packed	0.88 kg	1 set
MZ3SW250	M1024569	1.38 kg	current transformer up to 250/5A for triple pole measurement, class 1 set = 3 pieces current transformer with distance tubes for level adjustment, 3 pieces installed in the current transformer	1.38 kg	1 set
SZ1SW250	L1024568	-	current transformer up to 250/5A, class 1, for single pole measurement	0.43 kg	1 piece
MZPR600	S1024597	-	distance tube for level adjustment, up to 600/5A, supplementary set for neighbouring MULTIVERT® without measurement to obtain uniform profile in height 1 set = 3 pieces	0.62 kg	1 set

Labelling facilities

Catalog number	Item number	Weight	Design	Weight	Package
MZBT	B222181	34 g	label holder size 1, 2, 3	0.03 kg	1 piece

MULTIVERT® 250A

Size 1, 690VAC

ACCESSORIES



1.002.909



1.002.910



22SZVK42



1.000.099



1.003.286



1.001.667



1.003.377



1.002.255

Varieties of cable termination

Catalog number	Item number	Weight	Design	Weight	Package
1.002.909	K1024613	0.243 kg	V-terminal clamp size 1,2,3, 95-240 mm ² single solid, 70-240 mm ² single stranded, 50-185 mm ² round stranded, 70-240 mm ² round solid, M = 23 -27 Nm 1 set = 3 pieces	0.243 kg	1 set
1.002.910	L1024614	0.26 kg	V-terminal clamp size 1,2,3, 95-300 mm ² single solid, 70-240 mm ² single stranded, 50-185 mm ² round stranded, 70-240 mm ² round solid, M = 23 -27 Nm 1 set = 3 pieces	0.258 kg	1 set
22SZVK42	Q1024618	0.1736 kg	V-terminal clamp size 1,2,3 for 2 conductors 50-240 mm ² single solid, 50-185 mm ² single stranded, 50-185 mm ² round stranded, 70-240 mm ² round solid M = 23-27 Nm	6.8 g	1 piece
1.000.099	E1023436	0.1 g	insulation cap for V-terminal clamp size 1,2,3	0.1 g	1 piece
1.003.286	Q1024595	0.311 kg	supplementary set for V-terminal size 1,2,3 set = 3 pieces V-clamps, cover shroud and labels for size 1, 2 and 3	0.232 kg	1 set
1.001.667	F1023275	0.23 kg	adapter for double terminal L3	0.25 kg	1 piece
1.003.377	Y1024579	1.743 kg	supplementary set for multiple termination, top terminal 2 cable lugs Cu/Al: up to max. 300 mm ² round stranded, sectoral stranded, 3 cable lugs Cu: up to max. 150 mm ² round stranded, sectoral stranded, M = 32-38 Nm	1.743 kg	1 set
1.002.255	B1024582	1.682 kg	supplementary set for multiple termination, bottom terminal 2 cable lugs Cu/Al: up to max. 300 mm ² round stranded, sectoral stranded, 3 cable lugs Cu: up to max. 150 mm ² round stranded, sectoral stranded, M = 32-38 Nm	1.682 kg	1 set

MERSEN reserves the right to change, update or correct, without notice, any information contained in this datasheet.



Shah & Shah Enterprise

www.shahent.co.in